

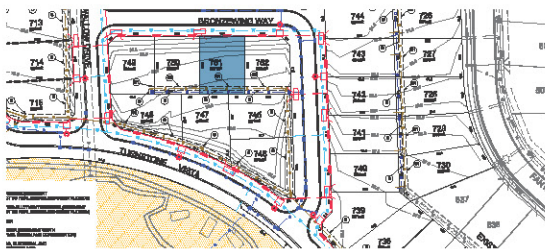

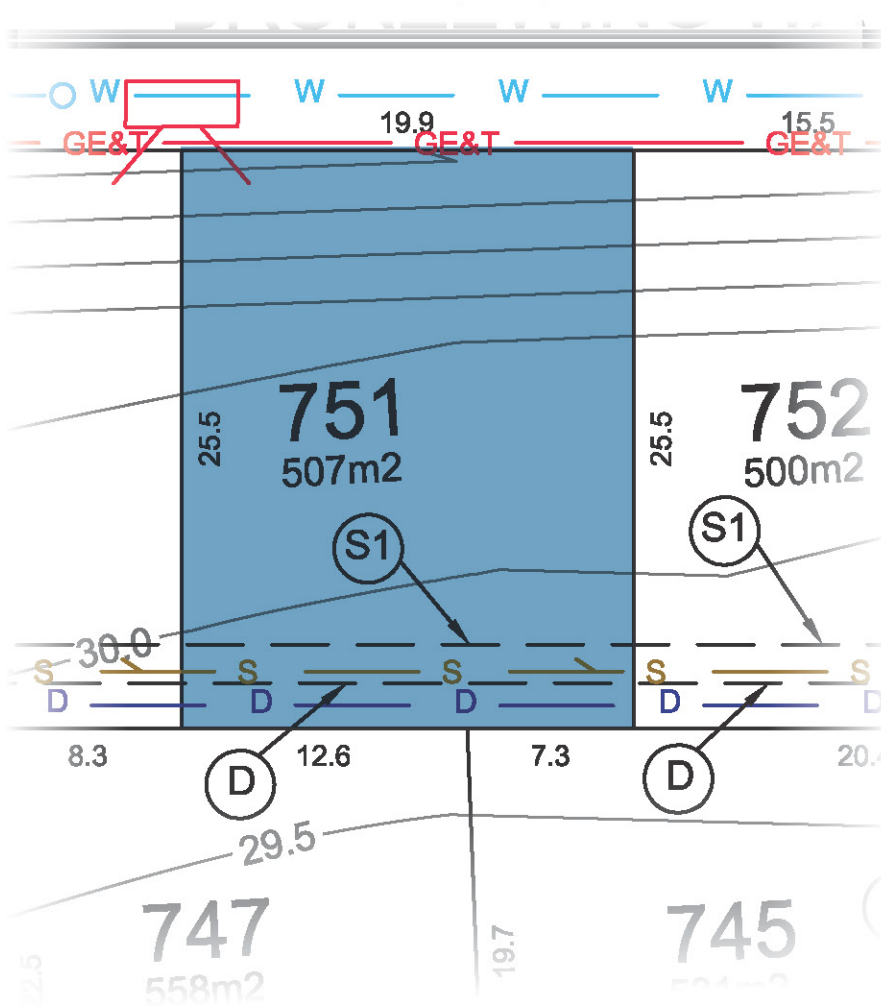









Bronzewing Way











DP:	DP1214872
Address:	6 Bronzewing Way SOUTH NOWRA
Lot Area:	507.0 m ²
Registration:	Registered
Soil Classification:	TBC
BAL Rating:	BAL LOW subject to individual assessment
Council:	Shoalhaven City

KEY:

-  (SUBJECT TO FINAL DESIGN AND CONSTRUCTION)
-  PROPOSED GAS, ELECTRICAL AND TELECOMMUNICATION LINES
-  EXISTING GAS, ELECTRICAL AND TELECOMMUNICATION LINES
-  PROPOSED WATER LINES
-  EXISTING WATER LINES
-  PROPOSED EASEMENTS
-  PROPOSED COLUMN AND LANTERN
-  PROPOSED ELECTRICAL PILLAR
-  EXISTING COLUMN AND LANTERN
-  EXISTING ELECTRICAL PILLAR
-  PROPOSED CONTOURS (INTERVAL 0.5m, SUBJECT TO FINAL DESIGN AND CONSTRUCTION)
-  PROPOSED RETAINING WALLS

EASEMENTS:

-  PROPOSED EASEMENT FOR DRAINAGE 2m WIDE (SUBJECT TO FINAL DESIGN AND CONSTRUCTION)
-  PROPOSED EASEMENT FOR SEWER 2.4m WIDE (SUBJECT TO FINAL DESIGN AND CONSTRUCTION)
-  PROPOSED EASEMENT FOR SEWER 3.7m WIDE (SUBJECT TO FINAL DESIGN AND CONSTRUCTION)
-  PROPOSED EASEMENT FOR SEWER 4.2m WIDE (SUBJECT TO FINAL DESIGN AND CONSTRUCTION)
-  PROPOSED EASEMENT FOR SEWER 4m WIDE (SUBJECT TO FINAL DESIGN AND CONSTRUCTION)
-  PROPOSED EASEMENT FOR SEWER 5m WIDE (SUBJECT TO FINAL DESIGN AND CONSTRUCTION)
-  EASEMENT FOR PADMOUNT SUBSTATION 2.75 WIDE (VIDE DP1179205)
-  EXISTING PAD MOUNT RESTRICTION ON THE USE OF LAI (VIDE DP1179205). BUILDINGS TO BE FIRE RATED IN THIS
-  EASEMENT RESTRICTION ON THE USE OF LAND (VIDE DP1179205). NO POOLS OR SPAS IN THIS AREA.

PLAN REFERENCE:

APA Plan Ref: 25481-300_02
 Plan of Subdivision Survey's Ref: 25481 S4
 Gas Details Supplied by Jemena
 Electricity Details by AKH Design
 Telecommunications by Design IT Telco P/L

Lot availability, Design Guidelines and current price list available at twinwatersestate.com.au

The material herein is intended as a guide only, no liability for negligence or otherwise is assumed for the material contained herein by Tovedale Developments, its principal or its servants or its agents. No material contained herein shall form the basis of or be part of any agreement and no warranty is given or implied as to the accuracy of the whole or any part of the material. Prospective purchasers should not rely on the material but should make their own enquiries and satisfy themselves of all aspects of the material. Any liability by Tovedale Developments, its servants or its agents in any way connected with this brochure, whether or not such liability results from or involves negligence, will not exceed \$1000.

Last Updated: July 2017